

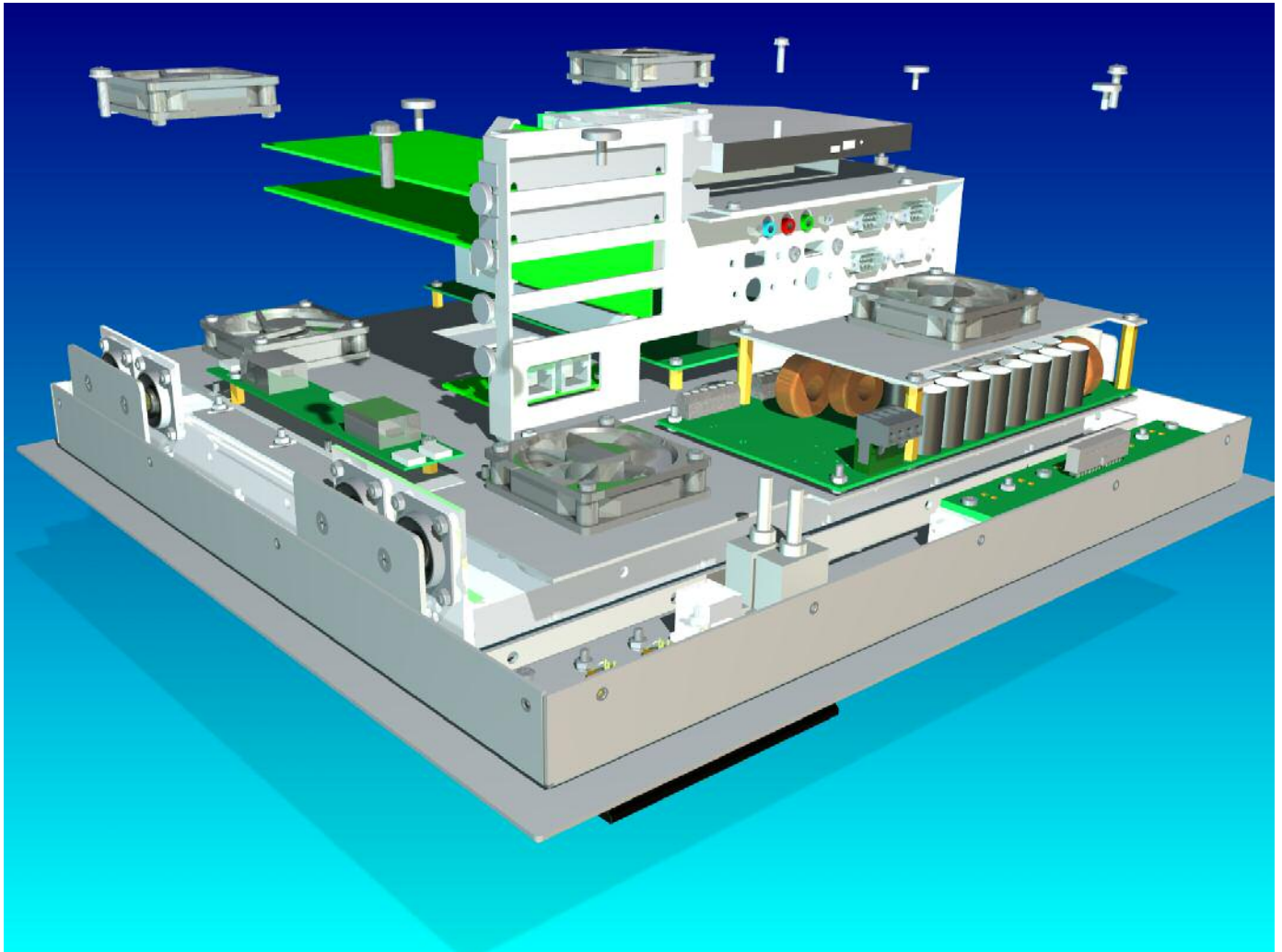

R&R Industrie-PC 123 / 17" mit Touchscreen

Gehäuse	Aluminium natur eloxiert Front Aluminium oder Edelstahl Mit und ohne Frontklappe Klemmmontage
Gehäuseschutzart B x H x T	IP 65 frontseitig ca. 430x 410 x 182 mm siehe Zeichnung DNR 15896

Elektronik und Laufwerke sind elastisch gelagert



Sichtscheibe resistiver Touchscreen

Touchscreencontroller
LANR 8364 Schnittstelle USB

Displays

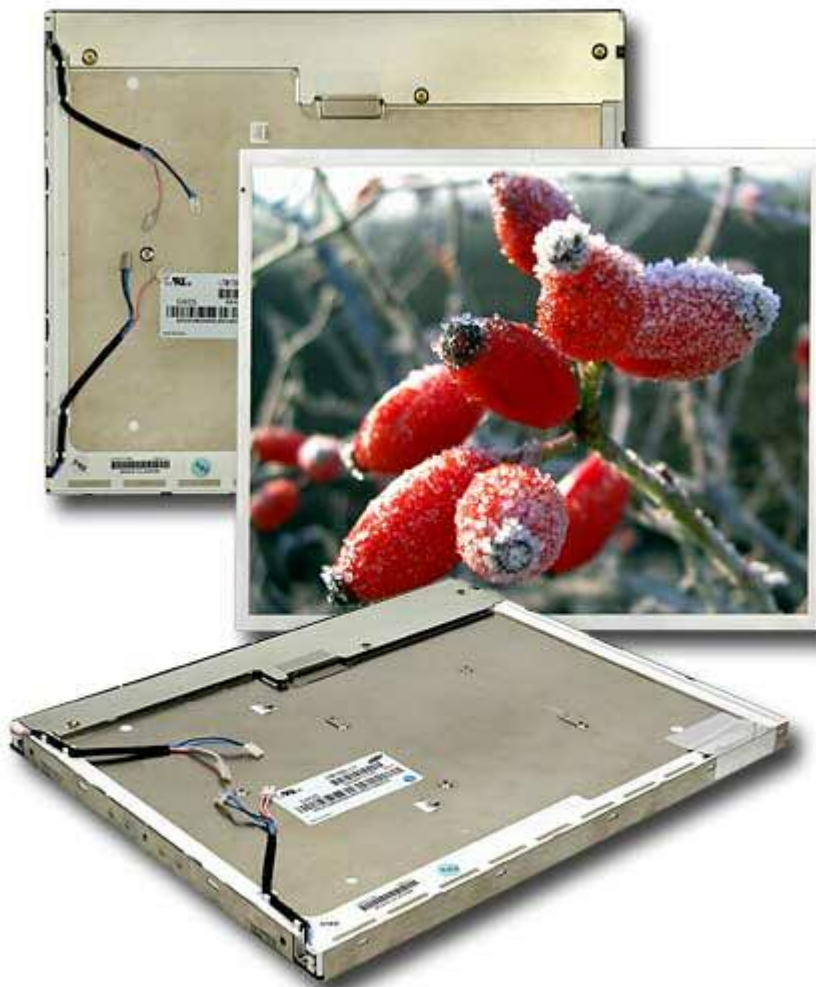

Display LANR 9377 17"
Auflösung SXGA, 1280 x1024
Helligkeit 300 cd/m²
Blickwinkel (v/h) 135°/150°
Kontrast 700 : 1

Display LANR 9578 17"
Auflösung SXGA 1280 x 1024
Helligkeit 250 cd/m²
Blickwinkel 179°/179°
Kontrast 1500 : 1

Rechnerplatine

z.B. Einplatinenrechner 5,25" SBC LANR 9455

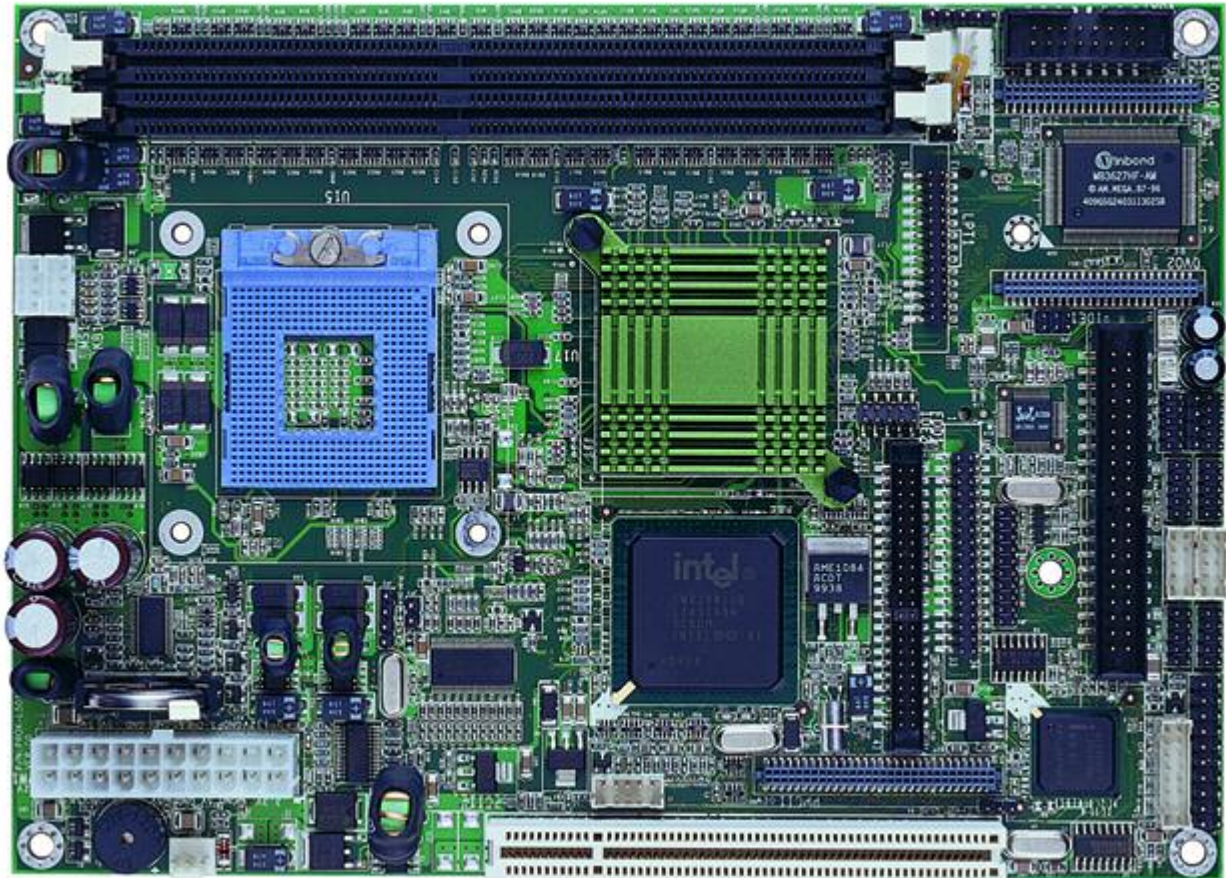

Prozessor	z.B. Pentium M 2 GHz FSB 400/ MHz
Hauptspeicher	2 x 184pin DDR SDRAM DIMM, max. 2GB (PC-266)
Chipsatz	INtel 855 GME + ICH4
Schnittstellen:	
LAN	LAN 1: Intel 82562EM (10/100 Mbps) LAN 2 Intel 82541GI (10/100/1000 Mbps):
USB 2.0	4x
Audio	AC 97 Codec, Realtec ALS202A with Line-in/Line-out/MIC
IRDA	1 (SIR)
Parallel Port	1x
serial Port	4x COM
FDD	1x
CF	1x Compact Flash

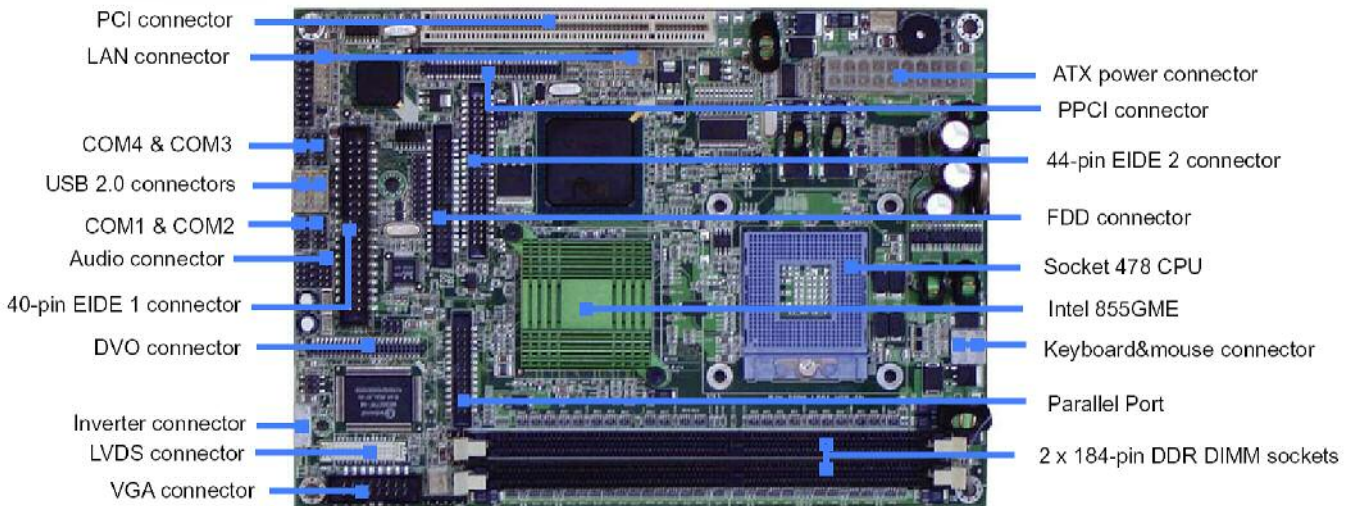
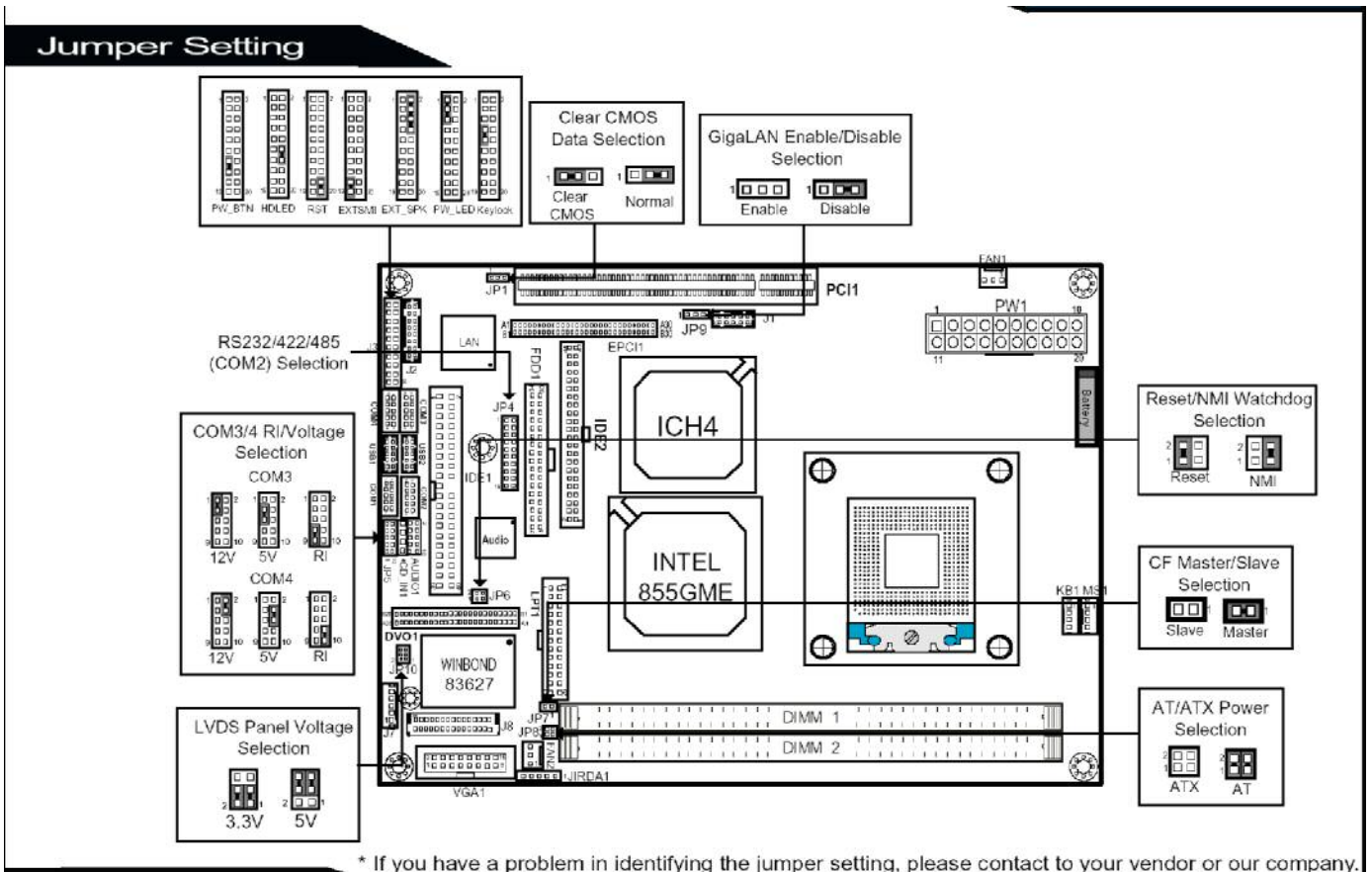

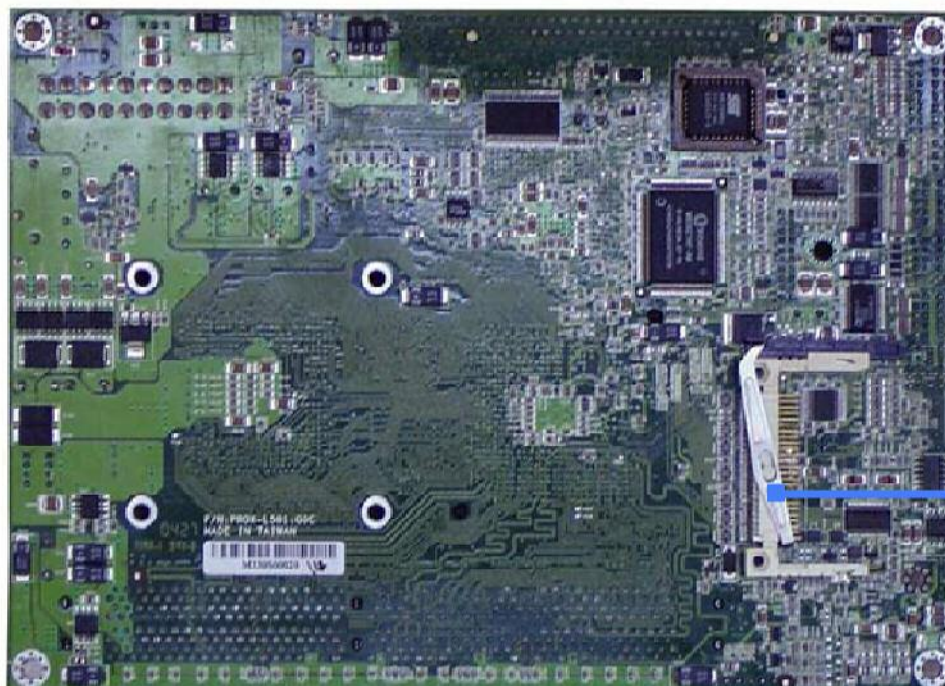

Compact Flash slot

Bedienelemente Frontseite

6 Tasten, Typ V6, Belegung kann variabel belegt werden
wahlweise mit integrierter 2farbiger LED

Steckverbinder frontseitig	1 x PS/2 Maus
hinter Dichtklappe	1 x PS/2 Tastatur
Schutzart im geschlossenen	2 x USB
Zustand IP54	1 x Ethernet



oder rückseitig



HDD
DVD
Betriebssystem

1 x 2,5 Zoll (\geq 40 GB)
Slim Line 1x (intern)
Windows XP professional

Systemerweiterungen

PCI-Riser-Karte
max. 2 PCI-Steckkarten



Netzwerkarte (4fach)

10/100 Base-TX RJ-45 4x



Stromversorgung RR-P-433B 24V / DC ATX Netzteil
Ausgangsspannungen 12V 9A
5V 9A
3.3V 5A
5V Standby 500 mm
Optionen -5V
Erweiterungsplatine -12V

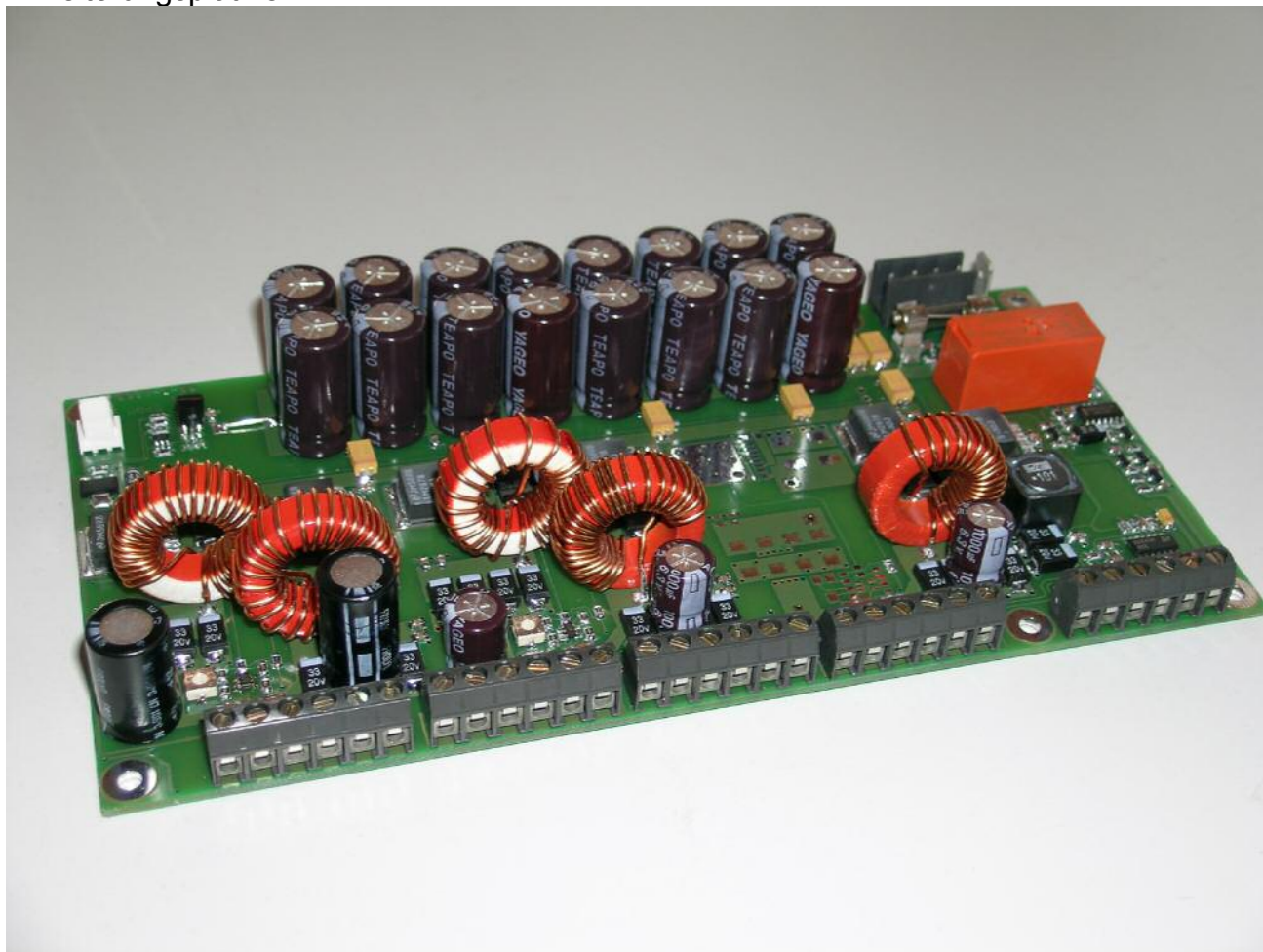

Steckerbelegungen

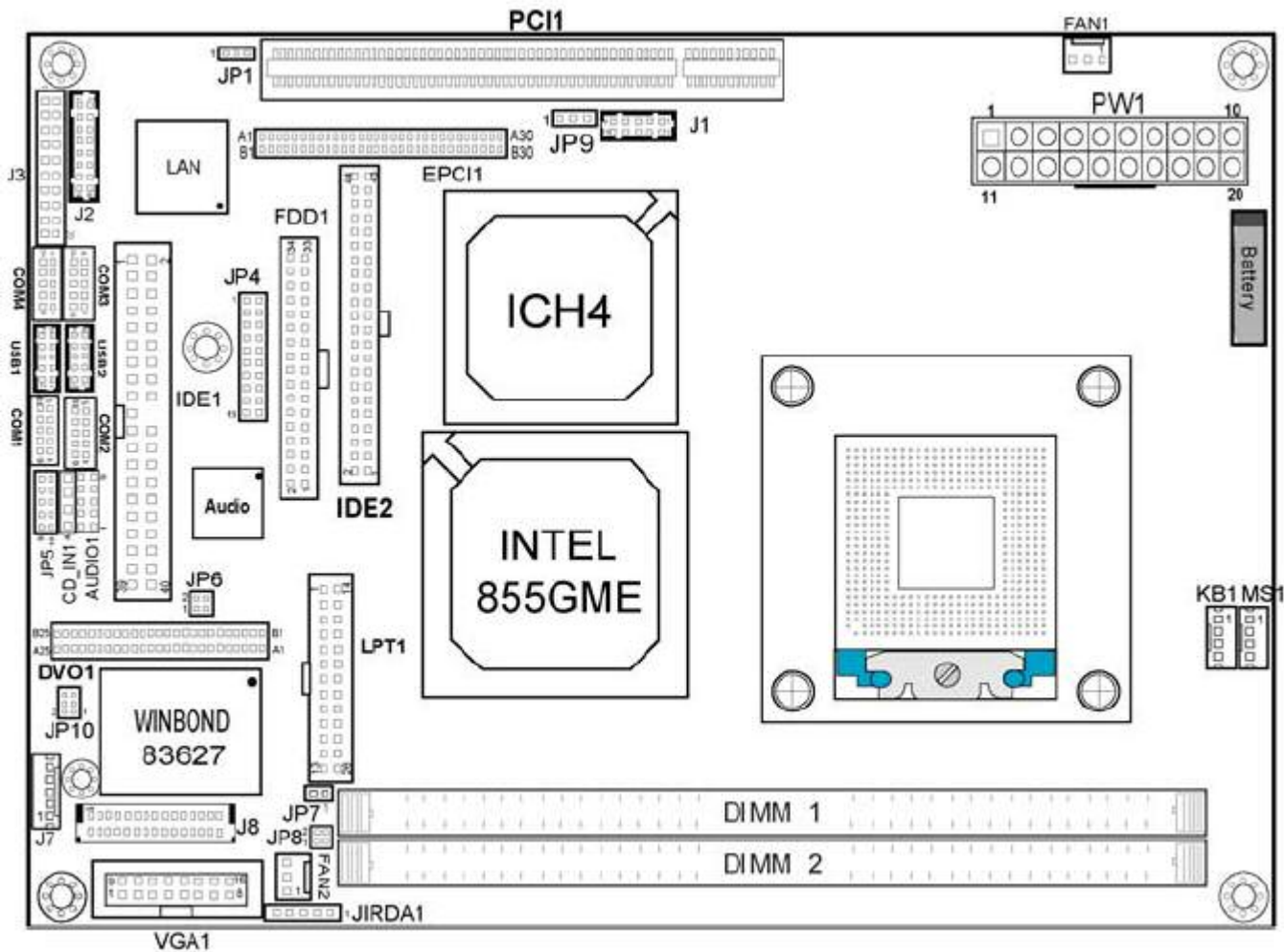

COM1 : COM1 Connector

COM1 is fixed as RS-232.

The pin assignment is as follows :

PIN	ASSIGNMENT
1	DCD1
2	RX1
3	TX1
4	DTR1
5	GND
6	DSR1
7	RTS1
8	CTS1
9	RI1
10	NC

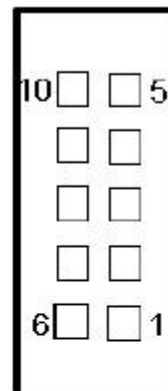

COM1

COM2 : COM2 Connector

The COM2 is selectable as RS-232/422/485.

The pin assignment is as follows :

PIN	ASSIGNMENT		
	RS-232	RS-422	RS-485
1	DCD2	TX-	TX-
2	RX2	TX+	TX+
3	TX2	RX+	RX+
4	DTR2	RX-	RX-
5	GND	GND	GND
6	DSR2	RTS-	NC
7	RTS2	RTS+	NC
8	CTS2	CTS+	NC
9	RI2	CTS-	NC
10	NC	NC	NC

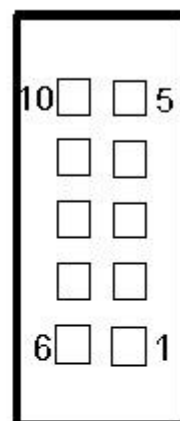

COM2

COM3 : COM3 Connector

COM1 is fixed as RS-232.

The pin assignment is as follows :

PIN	ASSIGNMENT
1	DCD3
2	RX3
3	TX3
4	DTR3
5	GND
6	DSR3
7	RTS3
8	CTS3
9	RI-V3
10	NC

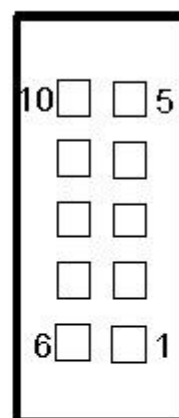
**COM3****COM4 : COM4 Connector**

COM1 is fixed as RS-232.

The pin assignment is as follows :

PIN	ASSIGNMENT
1	DCD4
2	RX4
3	TX4
4	DTR4
5	GND
6	DSR4
7	RTS4
8	CTS4
9	RI-V4
10	NC

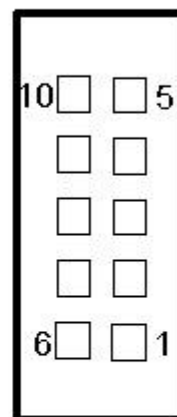
**COM4**

COM 2 Function	Jumper Settings (pin closed)	Jumper Illustrations
RS-232	Open	<p style="text-align: center;">JP4</p>
RS-422	1-2, 5-6, 7-8 9-10, 11-12, 13-14 15-16, 17-18, 19-20	<p style="text-align: center;">JP4</p>
RS-485	1-3, 4-6, 7-8, 9-10 11-12, 13-14, 15-16 17-18, 19-20	<p style="text-align: center;">JP4</p>

JP5 : COM3/4 RI & Voltage Selection The selections are as follows:

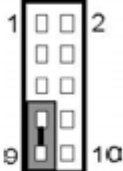
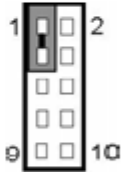
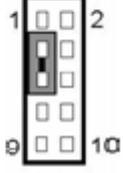
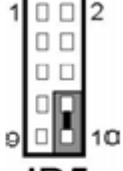
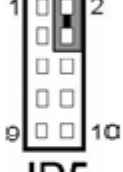
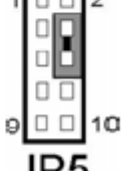
SELECTION		JUMPER SETTINGS	JUMPER ILLUSTRATION
COM3	RI	7-9	 JP5
	+12	1-3	 JP5
	+5V	3-5	 JP5
COM4	RI	8-10	 JP5
	+12	2-4	 JP5
	+5V	4-6	 JP5

***Manufacturing Default – RI.

KEYBOARD CONNECTOR

KB1 : Keyboard Connector

The pin assignments are as follows :

PIN	ASSIGNMENT
1	KBCLK
2	KBDAT
3	GND
4	KBMSVCCL

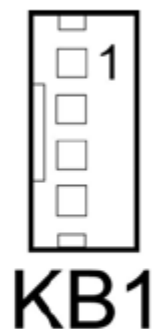

MOUSE CONNECTOR

MS1 : Mouse Connector

The pin assignments are as follows :

PIN	ASSIGNMENT
1	MSCLK
2	MSDAT
3	GND
4	KBMSVCCL

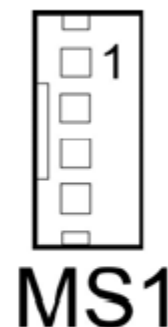

RESET CONNECTOR

J3 (18,20) : Reset Connector.

The pin assignment is as follows :

PIN	ASSIGNMENT
18	HWRSTJ
20	GND



HARD DISK DRIVE LED CONNECTOR

J3 (12, 14) : Hard Disk Drive LED Connector

The pin assignment is as follows :

PIN	ASSIGNMENT
12	P HLED
14	PULL HIGH VCC

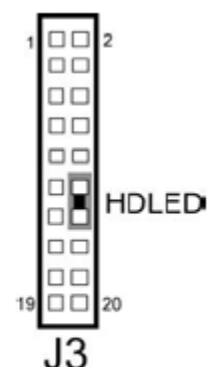

ATX POWER BUTTON

J3 (13, 15) : ATX Power Button

The pin assignment is as follows :

PIN	ASSIGNMENT
13	PW BN1
15	PW BN2

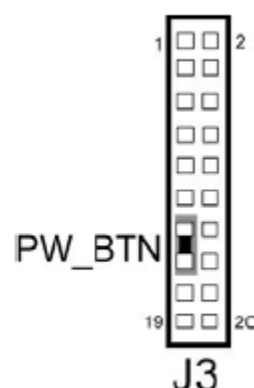

EXTERNAL SPEAKER CONNECTOR

J3 (2, 4, 6, 8) : External Speaker Connector

The pin assignment is as follows :

PIN	ASSIGNMENT
2	+5V
4	GND
6	NC
8	P SPK

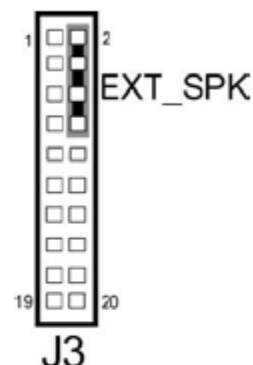

POWER LED CONNECTOR

J3 (1, 3, 5) : Power LED Connector

The pin assignment is as follows:

PIN	ASSIGNMENT
1	PW LED
3	PW LED
5	GND

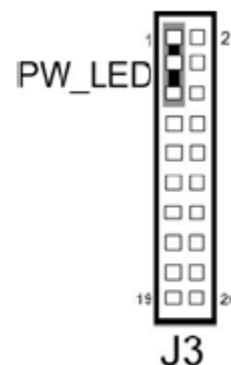

KEYLOCK CONNECTOR

J3 (7, 9) : Keylock Connector

The pin assignment is as follows:

PIN	ASSIGNMENT
7	KEYLOCK
9	GND

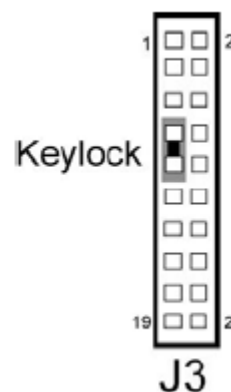

EXTSMI CONNECTOR

J3 (17, 19) : EXTSMI Connector

The pin assignment is as follows:

PIN	ASSIGNMENT
17	P ESMI
19	GND

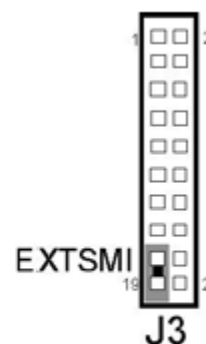

IRDA CONNECTOR

JIRDA1: IrDA (Infrared) Connector

The pin assignments are as follows:

PIN	ASSIGNMENT
1	+5V
2	NC
3	IRRX
4	GND
5	IRTX



CPU FAN CONNECTOR

FAN1 : CPU Fan connector

The pin assignment is as follows:

PIN	ASSIGNMENT
1	GND
2	+12V
3	FANIO1

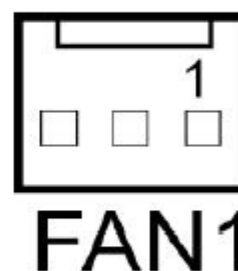

SYSTEM FAN CONNECTOR

FAN2 : System Fan connector

The pin assignment is as follows:

PIN	ASSIGNMENT
1	GND
2	+12V
3	FANIO2

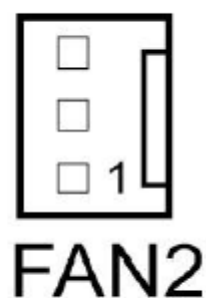

VGA CONNECTOR

VGA1 : VGA CRT Connector

The pin assignments are as follows:

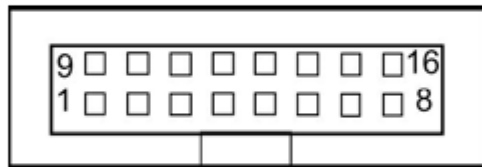

VGA1

PIN	ASSIGNMENT
1	RED
2	GREEN
3	BLUE
4	NC
5	GND
6	GND
7	GND
8	GND
9	VGA P5V
10	GND
11	NC
12	VGA 5VDDA
13	VGA HSYNC 5V
14	VGA VSYNC 5V
15	VGA 5VDDCLK
16	NC

HARD DISK DRIVE CONNECTOR

IDE1: Hard Disk Drive Connector

The pin assignments are as follows:

PIN	ASSIGNMENT	PIN	ASSIGNMENT
1	IDERSTJ	2	GND
3	PDD7	4	PDD8
5	PDD6	6	PDD9
7	PDD5	8	PDD10
9	PDD4	10	PDD11
11	PDD3	12	PDD12
13	PDD2	14	PDD13
15	PDD1	16	PDD14
17	PDD0	18	PDD15
19	GND	20	NC
21	PDREQ	22	GND
23	PDIOWJ	24	GND
25	PDIORJ	26	GND
27	PIORDY	28	PULL LOW
29	PDDACKJ	30	GND
31	IRQ14S	32	NC
33	PDA1	34	P66 DET
35	PDA0	36	PDA2
37	PDCSJ1	38	PDCSJ3
39	IDEACTPJ	40	GND

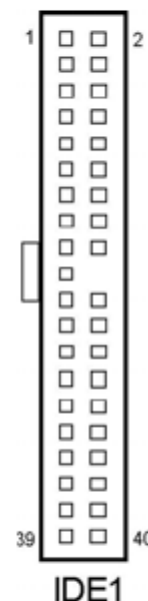

IDE2: Hard Disk Drive Connector
 The pin assignments are as follows:

PIN	ASSIGNMENT	PIN	ASSIGNMENT
1	IDERSTJ	2	GND
3	SDD7	4	SDD8
5	SDD6	6	SDD9
7	SDD5	8	SDD10
9	SDD4	10	SDD11
11	SDD3	12	SDD12
13	SDD2	14	SDD13
15	SDD1	16	SDD14
17	SDD0	18	SDD15
19	GND	20	NC
21	SDREQ	22	GND
23	SDIOWJ	24	GND
25	SDIORJ	26	GND
27	SIORDY	28	PULL LOW
29	SDDACKJ	30	GND
31	IRQ15S	32	NC
33	SDA1	34	S66 DET
35	SDA0	36	SDA2
37	SDCSJ1	38	SDCSJ3
39	IDEACTSJ1	40	GND
41	+5V	42	+5V
43	GND	44	GND

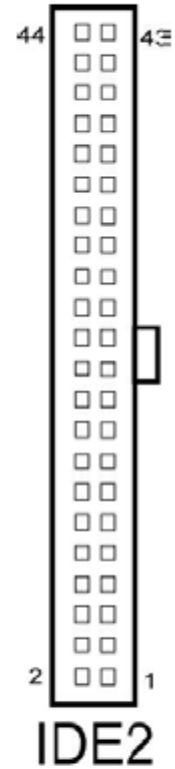

FLOPPY DISK DRIVE CONNECTOR

FDD1 : Floppy Disk Drive Connector

You can use a 34-pin daisy-chain cable to connect two-FDDs. On one end of this cable is a 34-pin flat cable to attach the FDD on the board, and the other side is attaches two FDDs.

The pin assignments are as follows :

PIN	ASSIGNMENT	PIN	ASSIGNMENT
1	GND	2	RWCJ
3	GND	4	NC
5	NC	6	DSIJ
7	GND	8	INDEX
9	GND	10	MOAJ
11	GND	12	DSBJ
13	GND	14	DSAJ
15	GND	16	MOBJ
17	GND	18	DIRJ
19	GND	20	STEPJ
21	GND	22	WDJ
23	GND	24	WEJ
25	GND	26	TRAK0
27	GND	28	WP#
29	NC	30	RDATA
31	GND	32	HEADJ
33	NC	34	DSKCHG

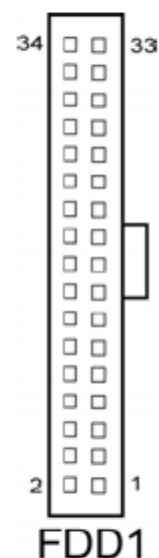

PRINTER CONNECTOR

PRNT1 : Printer Connector

As to link the Printer to the card, you need a cable to connect both DB25 connector and parallel port.

The pin assignments are as follows :

PIN	ASSIGNMENT	PIN	ASSIGNMENT
1	RSTBJ	14	AFDJ
2	RPD0	15	ERRJ
3	RPD1	16	PAR INITJ
4	RPD2	17	SLINJ
5	RPD3	18	GND
6	RPD4	19	GND
7	RPD5	20	GND
8	RPD6	21	GND
9	RPD7	22	GND
10	ACKJ	23	GND
11	BUSY	24	GND
12	PE	25	GND
13	SLCT	26	NC

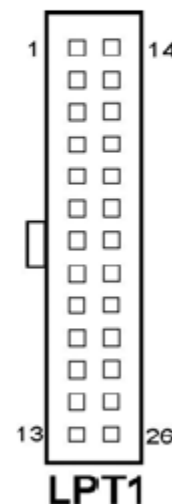

UNIVERSAL SERIAL BUS CONNECTOR

USB1: Universal Serial Bus Connector

The pin assignments are as follows:

PIN	ASSIGNMENT
1	VCCUSB0
2	VCCUSB1
3	USBP0N
4	USBP1N
5	USBP0P
6	USBP1P
7	GND
8	GND
9	GND
10	GND

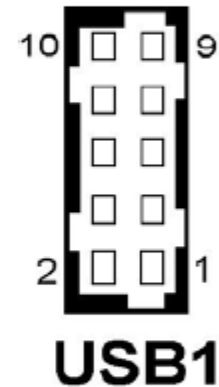

USB2: Universal Serial Bus Connector

The pin assignments are as follows:

PIN	ASSIGNMENT
1	VCCUSB2
2	UCCUSB3
3	USBP2N
4	USBP3N
5	USBP2P
6	USBP3P
7	GND
8	GND
9	GND
10	GND

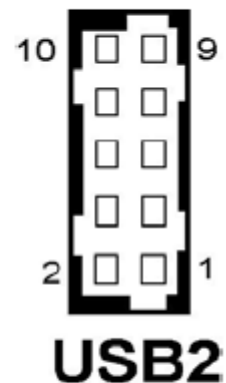

LAN CONNECTOR

LAN1: LAN Connector

The pin assignments are as follows:

PIN	ASSIGNMENT
1	TDP
2	PULL HIGH VCC3_3 Stand By
3	TDN
4	LILEDJ
5	GND
6	SPLEDJ
7	RDP
8	ACTLEDJ
9	RDN
10	NC



J1

LAN2: LAN Connector

The pin assignments are as follows:

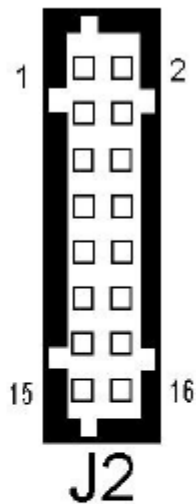

PIN	ASSIGNMENT
1	1MDI 3+
2	1MDI 3-
3	1MDI 2+
4	1MDI 2-
5	1MDI 1+
6	1MDI 1-
7	1MDI 0+
8	1MDI 0-
9	VCC25-CG
10	GND
11	1VCC3.3R
12	GND
13	1LINK-R
14	1ACT
15	1SPEED100
16	1SPEED1000-R



GIGALAN ENABLE/DISABLE SELECTION

JP9: GigaLAN Enable/Disable Selection.

The selections are as follows:

FUNCTION	JUMPER SETTING (pin closed)	JUMPER ILLUSTRATION
Enable	open	
Disable	2-3	

***Manufacturing Default is set as Enable.

CLEAR CMOS DATA SELECTION

JP1 : Clear CMOS Data Selection

The selections are as follows :

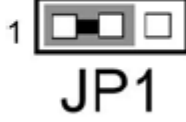
FUNCTION	JUMPER SETTING (pin closed)	JUMPER ILLUSTRATION
Normal	2-3	
Clear CMOS	1-2	

*** Manufacturing Default is set as Normal.

. AT/ATX POWER SELECTION

JP8 : AT/ATX Power Selection

The selections are as follows:

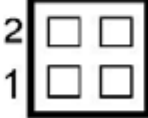
Power Selection	JUMPER SETTINGS (pin closed)	JUMPER ILLUSTRATION
AT	1-2, 3-4	 <p style="text-align: center;">JP8</p>
ATX	Open	 <p style="text-align: center;">JP8</p>

** Manufacturing default: ATX**

ATX POWER CONNECTOR

PW1 : ATX Power Connector

The pin assignments are as follows:

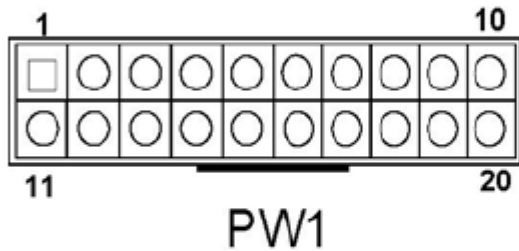



PIN	ASSIGNMENT
1	+3.3V
2	+3.3V
3	GND
4	+5V
5	GND
6	+5V
7	GND
8	NC
9	5VSB
10	+12V
11	+3.3V
12	-12V
13	GND
14	PS_ON
15	GND
16	GND
17	GND
18	-5V
19	+5V
20	+5V

RESET/NMI WATCHDOG SELECTION

JP6 : Reset/NMI Watchdog Selection

The selections are as follows:

FUNCTION	JUMPER SETTING (pin closed)	JUMPER ILLUSTRATION
RESET	1-2	 JP6
NMI	3-4	 JP6

** Manufacturing default: Reset.

. INVERTER CONNECTOR

J7 : Inverter Connector

The pin assignment is as follows:

PIN	ASSIGNMENT
1	+12
2	GND
3	+5V
4	GND
5	LVDS BKLTEN



LVDS CONNECTOR

J8 : LVDS Connector.

The pin assignments are as follows:

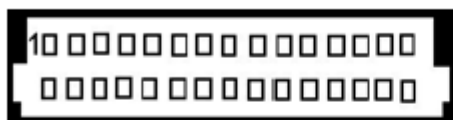

J8

PIN	ASSIGNMENT	PIN	ASSIGNMENT
1	LVDS VCC	2	GND
3	ZCM	4	ZCP
5	GND	6	Z2M
7	Z2P	8	GND
9	Z1M	10	Z1P
11	Z3P	12	Z3M
13	Z0P	14	Z0M
15	GND	16	YCP
17	YCM	18	GND
19	Y2P	20	Y2M
21	GND	22	Y1P
23	Y1M	24	GND
25	Y0P	26	Y0M
27	Y3P	28	Y3M
29	LVDS VCC	30	LVDS VCC

LVDS PANEL VOLTAGE SELECTION

JP10 : LVDS Panel Voltage Selection.

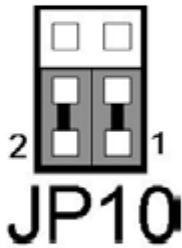
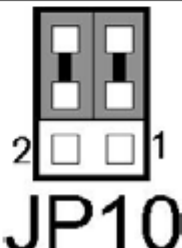

The selections are as follows:

SELECTION	JUMPER SETTING	JUMPER ILLUSTRATION
LVDS_VCC3	1-3, 2-4	 JP10
LVDS_VCC5	3-5, 4-6	 JP10

COMPACT FLASH MASTER/SLAVE SELECTION

JP7 : Compact Flash Master/ Slave Selection

The selections are as follows:

Power Selection	JUMPER SETTINGS (pin closed)	JUMPER ILLUSTRATION
Master	1-2	 JP7
Slave	Open	 JP7

** Manufacturing default: Master**

DVO CONNECTOR

DVO1 : DVO Connector.

The pin assignments are as follows:

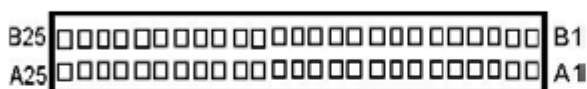

DVO1

PIN	ASSIGNMENT	PIN	ASSIGNMENT
A1	+5V	B1	+12V
A2	+5V	B2	+12V
A3	+5V	B3	GND
A4	+3.3V	B4	GND
A5	+3.3V	B5	DVOB D0
A6	VDDQ	B6	DVOB D1
A7	MI2C DATA	B7	DVOB D2
A8	MI2C CLK	B8	DVOB D3
A9	DVOB BLANKJ	B9	DVOB D4
A10	DVOB FLDSTL	B10	DVOB D5
A11	GND	B11	DVOB D6
A12	DVOB CLK	B12	DVOB D7
A13	DVOB CLKJ	B13	DVOB D8
A14	GND	B14	DVOB D9
A15	DVOB VSYNC	B15	DVOB D10
A16	DVOB HSYNC	B16	DVOB D11
A17	MDVI CLK	B17	DVOBC INTRJ
A18	MDVI DATA	B18	ADDDETECT
A19	PCIRSTJ	B19	ADDID4
A20	DVOB CCLKINTJ	B20	ADDID5
A21	ADDID0	B21	ADDID6
A22	ADDID1	B22	ADDID7
A23	ADDID2	B23	REF14.318M
A24	ADDID3	B24	VCC DIMM
A25	DVO VREF	B25	VCC DIMM

SOUND CONNECTOR

JAUDIO01 : Sound Connector.

The pin assignments are as follows:

PIN	ASSIGNMENT
1	MIC-IN
2	NC
3	GND
4	GND
5	LINE-L
6	LINE-R
7	GND
8	GND
9	SPK-L
10	SPK-R

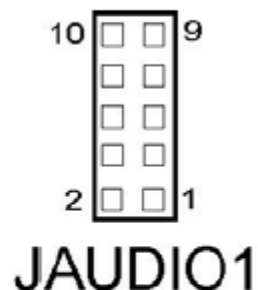

CD-IN CONNECTOR

CD-IN1 : CD-IN Connector.

The pin assignments are as follows:

PIN	ASSIGNMENT
1	CD-L
2	CD REF
3	CD REF
4	CD-R



PCI BUS PIN ASSIGNMENT

Like ISA-BUS connector, the PCI-BUS edge connector is also divided into two sets: one consists of 98-pin; the other consists of 22-pin.

The pin assignments are as follows :

B1				B49 B52			
A1				A49 A52			
PIN	B ASSIGNMENT	PIN	A ASSIGNMENT	PIN	B ASSIGNMENT	PIN	A ASSIGNMENT
B1	-12V	A1	TRST#	B31	+3.3V	A31	AD18
B2	TCK	A2	+12V	B32	AD17	A32	AD16
B3	GND	A3	TMS	B33	C/BE2#	A33	+3.3V
B4	TDO	A4	TDI	B34	GND	A34	FRAME#
B5	+5V	A5	+5V	B35	IRDY#	A35	GND
B6	+5V	A6	INTA#	B36	+3.3V	A36	TRDY#
B7	INTB#	A7	INTC#	B37	DEVSEL#	A37	GND
B8	INTD#	A8	+5V	B38	GND	A38	STOP#
B9	REQ3#	A9	CLKC	B39	LOCK#	A39	+3.3V
B10	REQ1#	A10	+5V(I/O)	B40	PERR#	A40	SDONE
B11	GNT3#	A11	CLKD	B41	+3.3V	A41	SB0#
B12	GND	A12	GND	B42	SERR#	A42	GND
B13	GND	A13	GND	B43	+3.3V	A43	PAR
B14	CLKA	A14	GNT1#	B44	C/BE1#	A44	AD15
B15	GND	A15	RST#	B45	AD14	A45	+3.3V
B16	CLKB	A16	+5V(I/O)	B46	GND	A46	AD13
B17	GND	A17	GNT0#	B47	AD12	A47	AD11
B18	REQ0#	A18	GND	B48	AD10	A48	GND
B19	+5V(I/O)	A19	REQ2#	B49	GND	A49	AD09
B20	AD31	A20	AD30	B52	AD08	A52	C/BE0#
B21	AD29	A21	+3.3V	B53	AD07	A53	+3.3V
B22	GND	A22	AD28	B54	+3.3V	A54	AD06
B23	AD27	A23	AD26	B55	AD05	A55	AD04
B24	AD25	A24	GND	B56	AD03	A56	GND
B25	+3.3V	A25	AD24	B57	GND	A57	AD02
B26	C/BE3#	A26	GNT2#	B58	AD01	A58	AD00
B27	AD23	A27	+3.3V	B59	+5V(I/O)	A59	+5V(I/O)
B28	GND	A28	AD22	B60	ACK64#	A60	REQ64#
B29	AD21	A29	AD20	B61	+5V	A61	+5V
B30	AD19	A30	GND	B62	+5V	A62	+5V

EPCI CONNECTOR

You will find a EPCI connector in our Prox-L501.
The pin assignments are as follows:

PIN	ASSIGNMENT	PIN	ASSIGNMENT
A1	GND	B1	GND
A2	AD0	B2	AD1
A3	AD2	B3	AD3
A4	AD4	B4	AD5
A5	AD6	B5	AD7
A6	AD8	B6	AD9
A7	AD10	B7	AD11
A8	VCC	B8	VCC
A9	AD12	B9	AD13
A10	AD14	B10	AD15
A11	AD16	B11	AD17
A12	AD18	B12	AD19
A13	AD20	B13	AD21
A14	AD22	B14	AD23
A15	VCC	B15	VCC
A16	AD24	B16	AD25
A17	AD26	B17	AD27
A18	AD28	B18	AD29
A19	AD30	B19	AD31
A20	PIRQ#B	B20	PAR
A21	PP CLK	B21	IRDY#
A22	ID SEL	B22	TRDY#
A23	CBE#0	B23	CBE#1
A24	CBE#2	B24	CBE#3
A25	PGNT#4	B25	PREQ#4
A26	SERR#	B26	PERR#
A27	PIRQ#A	B27	PCI_RST#
A28	STOP#	B28	PLOCK#
A29	DEVSEL#	B29	FRAME#
A30	GND	B30	GND

☐☞The EPCI expansion connector of this Card is designed based on PCI Bus Master.

COMPACT FLASH CARD CONNECTOR PIN ASSIGNMENT

The pin assignments of Compact Flash Card connector are stated below.

PIN	ASSIGNMENT	PIN	Assignment
1	GND	26	-CD1
2	D03	27	D111
3	D04	28	D121
4	D05	29	D131
5	D06	30	D141
6	D07	31	D151
7	-CS0	32	-CS11
8	A102	33	-VS1
9	-ATASEL	34	-IORD
10	A092	35	-IOWR
11	A082	36	-WE3
12	+3.3V	37	INTRQ
13	VCC	38	VCC
14	A062	39	-CSEL
15	A052	40	-VS2
16	A042	41	-RESET
17	A032	42	IORDY
18	A02	43	-INPACK
19	A01	44	-REG3
20	A00	45	-DASP
21	D00	46	-PDIAG
22	D01	47	D081
23	D02	48	D091
24	-IOCS16	49	D101
25	-CD2	50	GND

Zeichnung DNR 15896

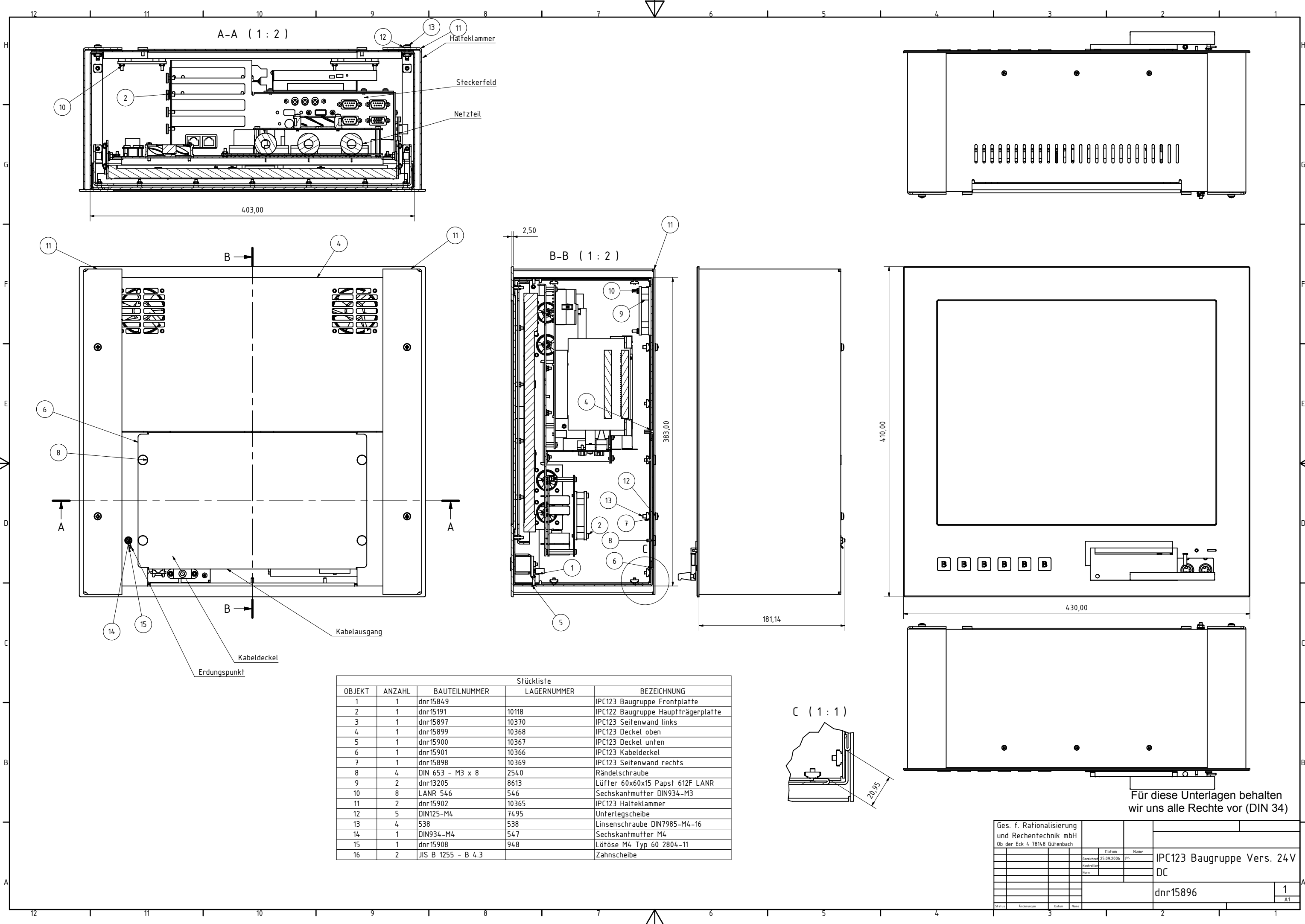

Stückliste				
OBJEKT	ANZAHL	BAUTEILNUMMER	LAGERNUMMER	BEZEICHNUNG
1	1	dnr15849		IPC123 Baugruppe Frontplatte
2	1	dnr15191	10118	IPC122 Baugruppe Hauptträgerplatte
3	1	dnr15897	10370	IPC123 Seitenwand links
4	1	dnr15899	10368	IPC123 Deckel oben
5	1	dnr15900	10367	IPC123 Deckel unten
6	1	dnr15901	10366	IPC123 Kabeldeckel
7	1	dnr15898	10369	IPC123 Seitenwand rechts
8	4	DIN 653 - M3 x 8	2540	Rändelschraube
9	2	dnr13205	8613	Lüfter 60x60x15 Papst 612F LANR
10	8	LANR 546	546	Sechskantmutter DIN934-M3
11	2	dnr15902	10365	IPC123 Halteklammer
12	5	DIN125-M4	7495	Unterlegscheibe
13	4	538	538	Linsenschraube DIN7985-M4-16
14	1	DIN934-M4	547	Sechskantmutter M4
15	1	dnr15908	948	Lötöse M4 Typ 60 2804-11
16	2	JIS B 1255 - B 4.3		Zahnscheibe

Für diese Unterlagen behalten wir uns alle Rechte vor (DIN 34)

Ges. f. Rationalisierung und Rechentechnik mbH Ob der Eck 4 78148 Güfenbach		Datum Name		IPC123 Baugruppe Vers. 24V DC
Gezeichnet	25.09.2006	PS		
Kontrolliert				dnr15896
Norm				
Status	Änderungen	Datum	Name	1 A1

12

11

10

9

8

7

6

5

4

3

2

1

H

G

F

E

D

C

B

A

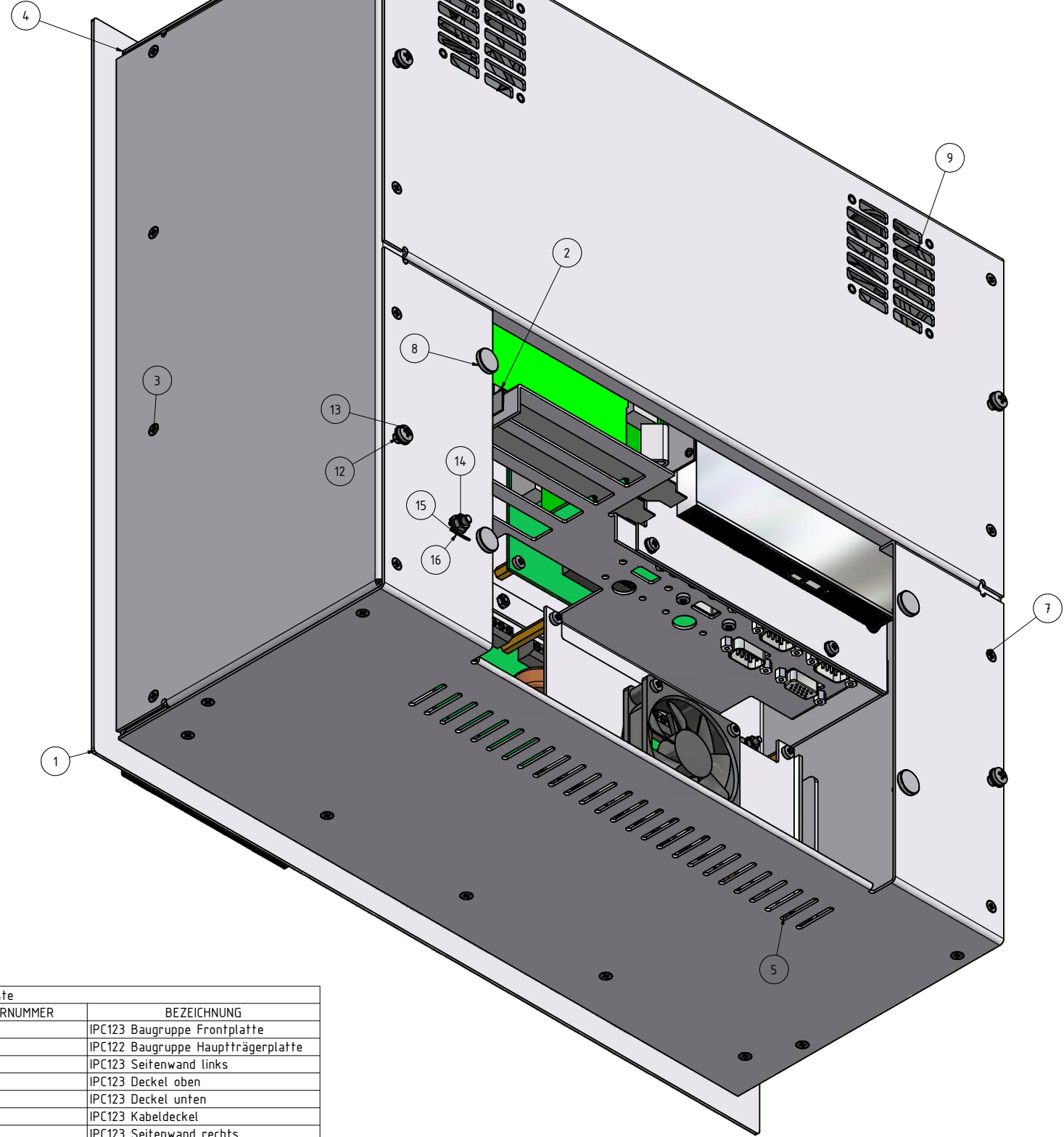

Stückliste				
OBJEKT	ANZAHL	BAUTEILNUMMER	LAGERNUMMER	BEZEICHNUNG
1	1	dnr15849		IPC123 Baugruppe Frontplatte
2	1	dnr15191	10118	IPC122 Baugruppe Hauptträgerplatte
3	1	dnr15897	10370	IPC123 Seitenwand links
4	1	dnr15899	10368	IPC123 Deckel oben
5	1	dnr15900	10367	IPC123 Deckel unten
6	1	dnr15901	10366	IPC123 Kabeldeckel
7	1	dnr15898	10369	IPC123 Seitenwand rechts
8	4	DIN 653 - M3 x 8	2540	Rändelschraube
9	2	dnr13205	8613	Lüfter 60x60x15 Papst 612F LANR
10	8	LANR 546	546	Sechskantmutter DIN934-M3
11	2	dnr15902	10365	IPC123 Halteklammer
12	5	DIN125-M4	7495	Unterlegscheibe
13	4	538	538	Linsenschraube DIN7985-M4-16
14	1	DIN934-M4	547	Sechskantmutter M4
15	1	dnr15908	948	Lötöse M4 Typ 60 2804-11
16	2	JIS B 1255 - B 4.3		Zahnscheibe

Für diese Unterlagen behalten wir uns alle Rechte vor (DIN 34)

Ges. f. Rationalisierung und Rechentechnik mbH Ob der Eck 4 78148 Güfenbach		Datum Name		IPC123 Baugruppe Vers. 24V DC
		25.09.2006	PS	
				dnr15896
				2 A1

12

11

10

9

8

7

6

5

4

3

2

1